

Small and High Accuracy Temperature Sensor IC Series

Analog Output Temperature Sensor IC

BD1020HFV

No.10047EBT02

●Description

Low quiescent current (4μA) and high accuracy temperature sensor
 Detecting temperature by itself, output voltage appears linearly along the temperature.

●Features

- 1) Detection Temperature Range -30~+100°C
- 2) Operating Voltage Range +2.4V~+5.5V
- 3) High Accuracy (typically ±1.0°C@Ta=30°C, typically ±2.0°C@Ta=-30~+100°C)
- 4) Temperature Sensitivity (typically -8.2mV/°C)
- 5) Low Quiescent Current (typically 4μA)
- 6) Ultra Small Package (typically 1.60mm×1.60mm×0.60mm)
- 7) Low Thermal Resistance (typically 187°C/W)
- 8) ESD Rating 8kV (HBM)
- 9) Excellent Ripple Rejection Characteristic

●Applications

Cell Phone (RF Module, Battery Thermal Management), Audio Systems, Digital Still Camera
 LCD, PDP, Optical pick up module for DVD, BlueRay

●Absolute Maximum Ratings (Ta=25°C)

PARAMETERS	SYMBOL	LIMIT	UNIT
Power Supply Voltage	V _{DD}	-0.3~7.0 ^{※1}	V
Output Voltage	V _{OUT}	-0.3~V _{DD} +0.3	V
Output Current	I _{OUT}	±1	mA
Power Dissipation	P _d	536 ^{※2}	mW
Storage Temperature Range	T _{stg}	-55~150	°C

※1. Not to exceed P_d

※2. Reduced by 5.36mW for each increase in Ta of 1°C over 25°C(mounted on 70mm×70mm×1.6mm Glass-epoxy PCB)

●Recommended Operating Condition

PARAMETERS	SYMBOL	MIN.	TYP.	MAX.	UNIT
Power Supply Voltage	V _{DD}	2.40	3.00	5.50	V
Operation Temperature	T _{opr}	-30	-	100	°C

●Electrical Characteristics and Accuracy (Unless otherwise specified, V_{DD}=3.0V, Ta=25°C)

PARAMETERS	SYMBOL	LIMIT			UNIT	CONDITIONS
		MIN.	TYP.	MAX.		
Accuracy	T _{acc}	-	±1.0	±1.5	°C	Ta = 30°C
		-	±2.0	±2.5		Ta = 100°C
		-	±2.0	±2.5		Ta = -30°C
Temperature Sensitivity	V _{SE}	-8.4	-8.2	-8.0	mV/°C	
Supply Current	I _S	-	4.0	7.0	μA	
Output Voltage	V _{OUT}	1.288	1.300	1.312	V	Ta = 30°C
Output VoltageLine Regulation	ΔV _{OUT} V _{DD}	-	-	4	mV	V _{DD} = 2.4~5.5V
Output VoltageLoad Regulation	ΔV _{OUT} R _L	-	-	1	mV	I _{OUT} : 0μA / 0.7μA, Difference

Radiation hardness is not designed.

●Package Outlines

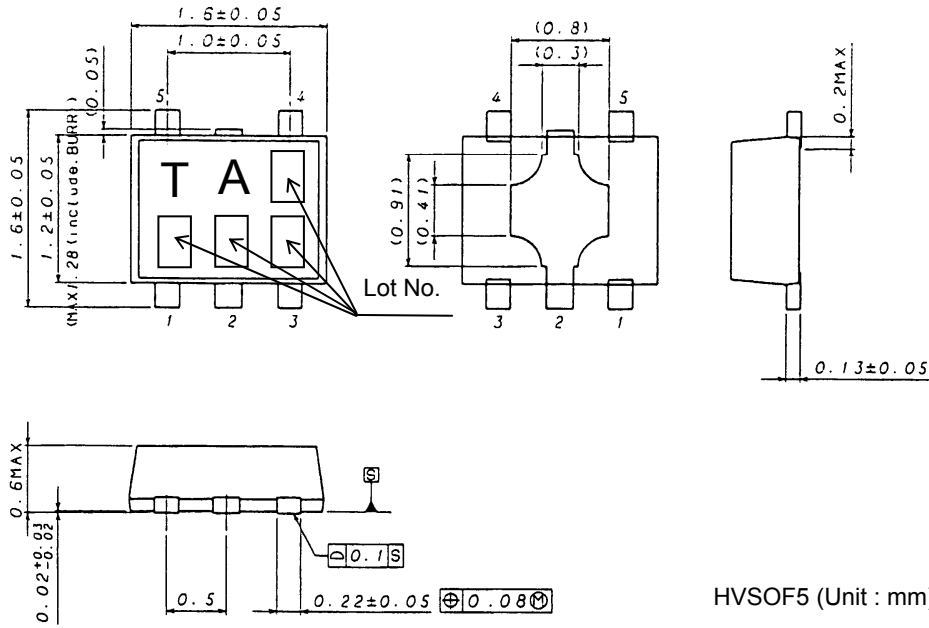

●Pin Descriptions

Pin No.	Pin Name	Function	Comment
1	N.C.	-	Please set to OPEN .
2	PG	Heat Condition	Please connect to temperature measurement part.
3	VOUT	Output Voltage for proportional temperature reversely	-
4	VDD	Power Supply	-
5	GND	Ground	-

●Block Diagram

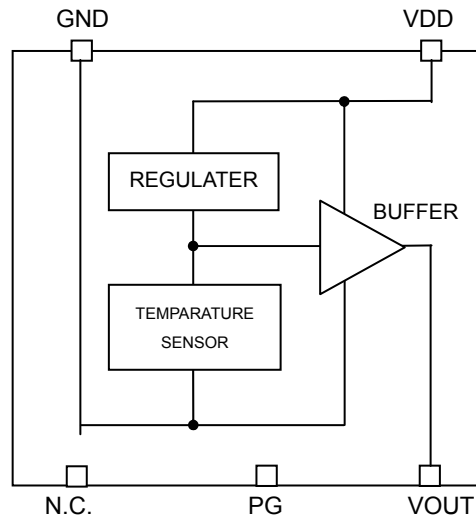

●Reference Data

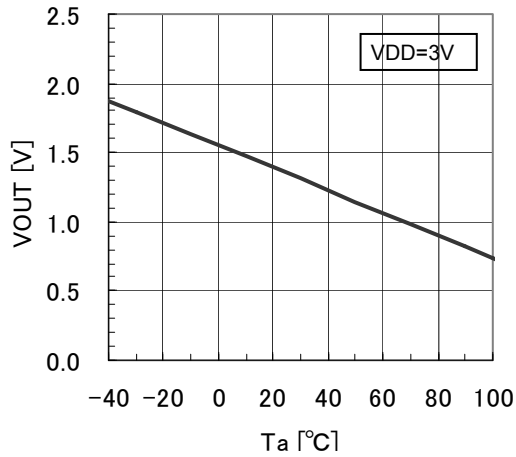

Fig.1 Output Voltage vs. Temperature

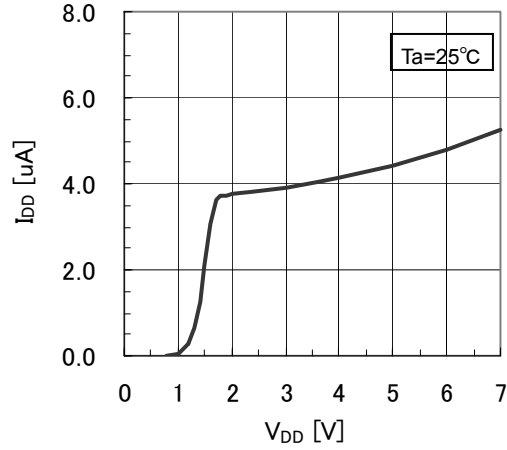

Fig.2 Supply Current vs. Supply Voltage

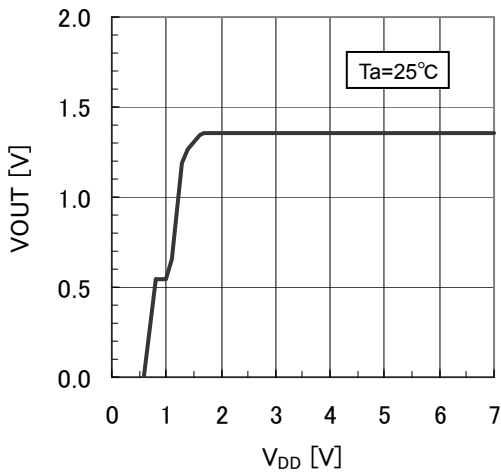

Fig.3 Output Voltage vs. Supply Voltage

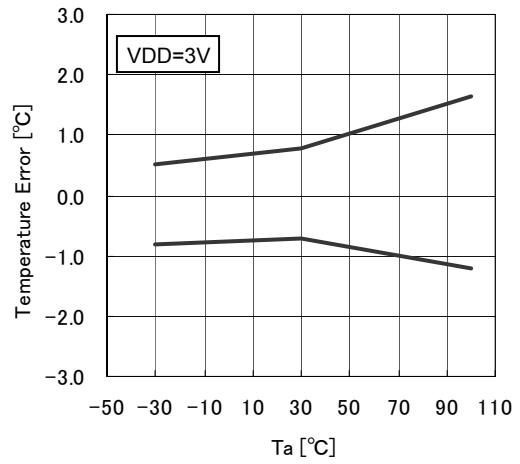

Fig.4 Error vs. Temperature

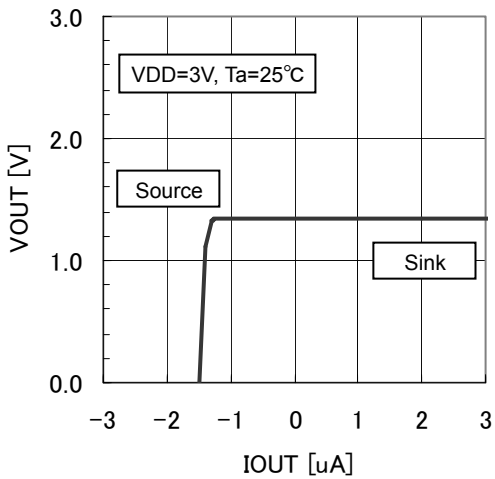

Fig.5 Output Voltage vs. Output Current

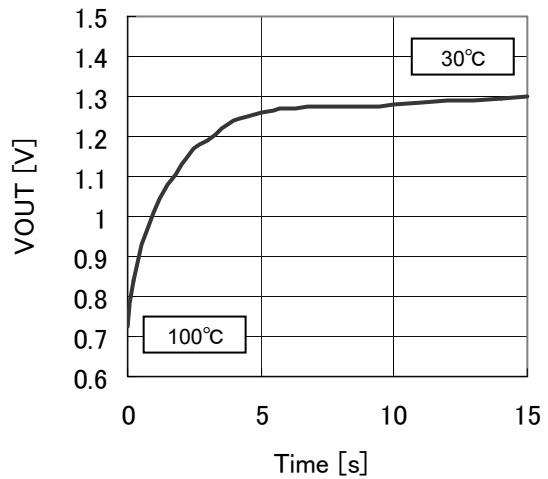

Fig.6 Start Up Response
(VOUT response 100°C→30°C in atmosphere)

●Notes for use

1) Absolute Maximum Ratings

An excess in the absolute maximum ratings, such as supply voltage, temperature range of operating conditions, etc., can break down devices, thus making impossible to identify breaking mode such as a short circuit or an open circuit. If any special mode exceeding the absolute maximum ratings is assumed, consideration should be given to take physical safety measures including the use of fuses, etc.

2) GND voltage

Make setting of the potential of the GND terminal so that it will be maintained at the minimum in any operating state.

3) Pin short and mistake fitting

When mounting the IC on the PCB, pay attention to the orientation of the IC. If there is a placement mistake, the IC may be burned up.

4) Operation in strong electric field

Be noted that using ICs in the strong electric field can malfunction them.

5) Mutual impedance

Use short and wide wiring tracks for the power supply and ground to keep the mutual impedance as small as possible.
Use a capacitor to keep ripple to a minimum.

6) Please connect it with the temperature measurement part (GND line usually) to make thermal conductivity with the mount board side the best though the PG pin (Pin NO.2) is hindered and doesn't exist about OPEN even if it connects it with GND.

●Ordering part number

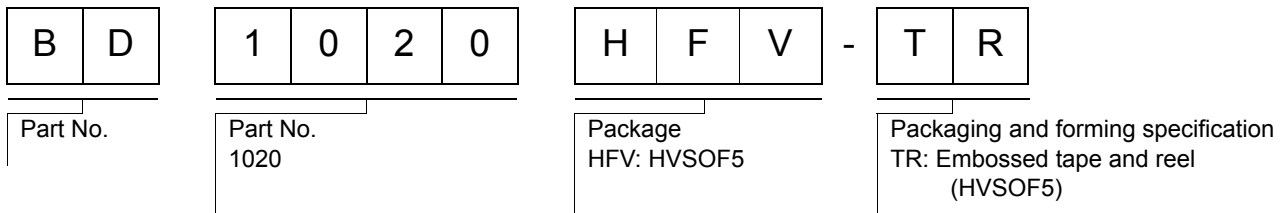

HVSO5F5

(Unit : mm)

<Tape and Reel information>

Tape	Embossed carrier tape
Quantity	3000pcs
Direction of feed	TR (The direction is the 1pin of product is at the upper right when you hold reel on the left hand and you pull out the tape on the right hand)

*Order quantity needs to be multiple of the minimum quantity.

Notes

No copying or reproduction of this document, in part or in whole, is permitted without the consent of ROHM Co.,Ltd.

The content specified herein is subject to change for improvement without notice.

The content specified herein is for the purpose of introducing ROHM's products (hereinafter "Products"). If you wish to use any such Product, please be sure to refer to the specifications, which can be obtained from ROHM upon request.

Examples of application circuits, circuit constants and any other information contained herein illustrate the standard usage and operations of the Products. The peripheral conditions must be taken into account when designing circuits for mass production.

Great care was taken in ensuring the accuracy of the information specified in this document. However, should you incur any damage arising from any inaccuracy or misprint of such information, ROHM shall bear no responsibility for such damage.

The technical information specified herein is intended only to show the typical functions of and examples of application circuits for the Products. ROHM does not grant you, explicitly or implicitly, any license to use or exercise intellectual property or other rights held by ROHM and other parties. ROHM shall bear no responsibility whatsoever for any dispute arising from the use of such technical information.

The Products specified in this document are intended to be used with general-use electronic equipment or devices (such as audio visual equipment, office-automation equipment, communication devices, electronic appliances and amusement devices).

The Products specified in this document are not designed to be radiation tolerant.

While ROHM always makes efforts to enhance the quality and reliability of its Products, a Product may fail or malfunction for a variety of reasons.

Please be sure to implement in your equipment using the Products safety measures to guard against the possibility of physical injury, fire or any other damage caused in the event of the failure of any Product, such as derating, redundancy, fire control and fail-safe designs. ROHM shall bear no responsibility whatsoever for your use of any Product outside of the prescribed scope or not in accordance with the instruction manual.

The Products are not designed or manufactured to be used with any equipment, device or system which requires an extremely high level of reliability the failure or malfunction of which may result in a direct threat to human life or create a risk of human injury (such as a medical instrument, transportation equipment, aerospace machinery, nuclear-reactor controller, fuel-controller or other safety device). ROHM shall bear no responsibility in any way for use of any of the Products for the above special purposes. If a Product is intended to be used for any such special purpose, please contact a ROHM sales representative before purchasing.

If you intend to export or ship overseas any Product or technology specified herein that may be controlled under the Foreign Exchange and the Foreign Trade Law, you will be required to obtain a license or permit under the Law.



Thank you for your accessing to ROHM product informations.
More detail product informations and catalogs are available, please contact us.

ROHM Customer Support System

<http://www.rohm.com/contact/>